

EFFECT OF VORTEX GENERATORS ON A FRICTION FACTOR IN AN EQUILATERAL TRIANGULAR DUCT

Hamdi E. A. Zangana
Uni. of Anbar – Mech. Eng. Depart.
E-mail: hamdi_engi@yahoo.com

ABSTRACT

The main objective of this study is to determine the effect of vortex generators on a friction factor for fully developed flow of a fluid such as air. Longitudinal vortices can be generated in a channel flow by punching or mounting protrusions in the channel wall. Such vortex generators (VGs) can be classified into delta wing, rectangular wing, pair of delta-winglet and pair of rectangular winglet. These longitudinal vortices disrupt the growth of the boundary layer and lead to enhance the heat transfer rate between the working fluid and the conductor channel wall, but this enhancement is associated with increasing in a pressure gradient along the axial length of the channel. So, the friction factor for fully developed air flow in an equilateral triangular duct is investigated experimentally with Reynolds number ranging from (31,000) to (53,000) and the size of the generators was kept constant for three cases which are single, double, and triple pairs of delta-winglet type of vortex generators embedded in the turbulent boundary layer for attack angle of generator of (30, 40, and 50) degree. The results show that the friction factor increases by about (43.5 %) when the angle of attack is varied from (30 deg) to (50 deg) for the triple pairs case compared with the base case (without VG).

KEYWORDS: Friction Factor, Vortex Generator, Triangular Duct, Fully Developed Turbulent flow.

1. INTRODUCTION

Vortex generators are used to enhance the heat transfer rate of the contact surface between the conductor channel walls and the working fluid as in the applications of compact heat exchangers design. But the presence of the vortex generator as an obstacle in the flow stream promotes the pressure drop losses at the trail of the generator and so the friction factor, because the cross-sectional area of the flow stream decreases. The former researchers investigated the pressure drop and heat transfer characteristics in a noncircular cross-section duct have found that the pressure drop in fully developed turbulent flow can also be estimated as a first approximation from turbulent flow correlation for circular duct if the diameter is replaced by the hydraulic diameter (D_h) of the particular cross-section. This is particularly true for fully developed turbulent flow in equilateral triangular ducts for which only minor deviation from the circular tube correlation for friction factor has been reported [1].

Furthermore, significant deviation from the circular tube correlation have been reported for the sharp cornered ducts such as isosceles triangular ducts with narrow apex-angle [2]. It also seems that the deviation in a friction factor correlation decreases as an apex-angle of triangular duct increases. But the main problem for the technique of heat transfer augmentation between the working fluid and conductor surface of the channel wall lies in the large additional pressure drop associated with increase in heat transfer rate, due to find a way which increases the heat transfer rate with smaller losses in the power supply to force the fluid inside the channel.

At the early time, the fully developed axial pressure drop in an equilateral triangular duct was studied experimentally and the results afforded that the deviation is ranged from (5 %) to (6.5 %) lower than values predicted by the Blasius correlation¹ for friction factor in smooth circular tubes. Hence the correlation for the deviation must include a geometrical factor (hydraulic diameter) in the correlation of friction factor and Reynolds number data gives a good representation [3].

Also, Altemani and Sparrow [4] performed an experimental research in an equilateral triangular duct, and found that the hydraulic diameter concept is not sufficient to rationalize the difference between the tube and triangular duct geometries. Chegini et al. [1] studied the pressure drop extensively in their experimental investigation with the isosceles and equilateral finned triangular ducts. It seems that the hydraulic diameter rule for computing friction factor carries a large and unacceptable uncertainty for laminar as well as turbulent regimes. Moreover, the isosceles triangular data has much larger scatter compared to the equilateral triangular duct. Carlson and Irvine [2] made experimental tests and noted that the turbulent friction factor for the circular tube correlation with the hydraulic diameter, predicts values some (20 %) high for a (4 deg) apex-angle, and (5 %) high at a (38 deg) angle.

The delta-winglet pair causes lower pressure drop and gives higher heat transfer rate than that of wing and winglet pair [5], see Fig (1).

Wroblewski et al. [6] and Dep et al. [7] studied analytically the laminar and turbulent boundary layer in a rectangular channel with a single-pair of delta-winglet type vortex generator. The results of ref. [6] show that the increase in peak values of the average skin friction coefficients are (33%) and (27%) for (Re) numbers of (5,000) and (15,000) respectively.

An extension of earlier work is made by Biswas et al. [8] and Biswas et. al. [9] who performed an analytical research to study the effect of the built-in delta-wing and winglet-pair type vortex generators in a rectangular channel. It is shown that the frictional loss for the built-in delta-wing in the channel is about (79%) more than that of a plane channel flow, while it is nearly (65%) for the delta-winglet pair at the same location, with the size of generators is kept constant and the angle of attack is (26deg).

Other researchers studied the effect of exist of a row (array) of a winglet-type vortex generator organized in such a way that periodically mounted in a one wall of a rectangular channel. Zhu et al [10] studied numerically four angles of attack from (15) deg to (45) deg and found that the increase in flow loss is much larger than the enhancement in (Nu) number when the vortex generators are used. Ketcioğlu et al. [11] arranged the arrays periodically interrupted divergent and convergent in the channel. The results show that the dependence of (Re) number on the friction factor is strong. An increase of heat transfer coefficient is observed with accompanying large pressure drop increasing with the inclination angle.

In a recent investigation, Zangana [12] studied experimentally the effect of delta-winglet type of vortex generator on a pressure head losses and heat transfer rate in an equilateral triangular duct. He studied a single, double, and triple pairs of generators embedded in the turbulent boundary layer. A (6 – 24) degree of angle of attack of generators was studied for two different sizes of generators. The study shows that the friction factor is directly proportional with the size of generators, number of generators and the angle of attack and inversely proportional with the flow rate. Moreover, he found that the friction factor increases slightly with the size of generators compared with Reynolds number as well as with the angle of attack of generator.

¹ $f = 0.316 / Re^{0.25}$

mixing of the fluids close to and far from the wall. If the fins are selected in the form of longitudinal vortex generators, then the additional heat transfer benefit coming from turning of the flow may exceed the benefit of increasing the heat transfer surface by fins.

The delta-winglet type of vortex generators was employed in this work for its advantages aforementioned in this paper. The angle of attack of the vortex generator can be varied to verify the effect of angle change on the friction factor values. The geometry of vortex generator was (5.0mm height, 27.5mm length). The location of the vortex generators is at $(2.8 D_h)$ downstream wise of the static pressure drop taps from the test section inlet, and the space between the pair of vortex generator is held constant at (35 mm).

2. MEASUREMENT SYSTEM

The quantities measured in an experimental run are the volumetric air flow rate and the pressure drop between the pressure taps located in the fully developed region of the test section. The measurements and instrumentation are:

2.1. Airflow Measurement

The volumetric air flow rate was measured by an orifice plate flow meter whose pressure taps were located one diameter upstream and half diameter downstream [13] according to the ISO 5167 orifice plate. The orifice plate was placed at a sufficient distance from the blower due to the fluctuation in the flow. The two taps of the upstream and downstream wise of the orifice plate were connected with the accurate inclined manometer by (PVC) tubes.

2.2. Static Pressure Measurement

The friction factor can be estimated using the head loss measurements through the test section. To estimate the static pressure drop through the test section, the upstream and downstream ends were drilled at midway of the side of each wall and then connected with an inclined manometer by (PVC) tubes. The static pressure holes are shown in Fig (2).

3. RESULTS AND DISCUSSION

Augmentation in heat transfer rate depends upon the value of increasing pressure drop. As it has been mentioned earlier, when the delta-winglet type vortex generator is used (to enhance heat transfer coefficient) the increase in pressure drop is relatively low. The experiments are carried out using one size of vortex generator embedded in the turbulent boundary layer through triangular duct. In addition, three groups of tests namely single (I), double (II), and triple (III) pairs of generators with three attack angles of generators were studied while Reynolds number ranges from (31,000) to (53,000). Parameters such as Reynolds number, number of vortex generators, and the angle of attack of generator are studied in the current investigation.

3.1. Duct Friction Factor

To check the validity of the experimental apparatus in laboratory, pretests were performed without using vortex generators (standard case) and the data obtained from these tests was compared with the experimental data of the previous investigations to verify the amplitude of coincidence between them. This comparison is represented schematically in Fig (3). The Blasius [14], Petukhov–Popov and Prandtl [4] correlations deal with circular tubes, whereas the Altemani–Sparrow [4] and Chegini–Chaturvedi [1] correlations deal with equilateral triangular ducts. The blackened circles represent the present results. The Blasius, Petukhov–Popov, Prandtl, and Chegini correlations are shown to over predict the present data by about (9.7, 8.8, 7.6, and 6.5) percent, respectively, whereas the present data over predicts the data of Altemani–Sparrow by about (1.7) percent. The deviation of the present data gives

a reasonable agreement with the data particular for circular tubes and as well as with the data of a triangular duct.

In each case, the measured axial pressure gradient yielded, a straight line on a pressure versus (x) axial coordinate where it was computed from the following dimensionless form via the friction factor (f):

$$f = \frac{\Delta P}{\left(\frac{L}{D_h}\right) \left(\frac{\rho \bar{u}^2}{2}\right)} \quad (1)$$

The Reynolds number is defined as:

$$Re = \frac{D_h \bar{u}}{\nu} = \frac{m^* D_h}{\mu A} \quad (2)$$

Utilizing the relationship between the friction factor and Reynolds number, a correlation is determined and compared with the previous experimental results. The simplified form of the present correlation is:

$$f = f(Re) \quad (3)$$

The equation formula that is used in previous investigations can be written as follows:

$$f = c / (Re)^d \quad (4)$$

The data of the standard case follows the correlation:

$$f = 0.285 / Re^{0.25} \quad (5)$$

Whereas the Blasius [14] and Chegini [1] correlations for smooth tubes and equilateral triangular ducts are respectively as follows,:

$$f = 0.316 / Re^{0.25} \quad (6)$$

$$f = 0.305 / Re^{0.25} \quad (7)$$

The deviation between Eq.(5) and Eq.(6) and (7) is about (9.96%) and (6.61%), respectively. This result shows a good agreement.

3.2. Effect of Vortex Generator Number on the Duct Friction Factor

It seems clearly that the friction factor is inversely proportional with (Re) number and directly proportional with the vortex generators number. The latter relationship can be attributed to the decrease in cross-sectional area of the flow at the vortex generators location. A high pressure drop occurs in the immediate neighborhood behind the winglet-body junction which eventually causes promotion of friction factor downwise of that location. The effect of Reynolds number on the friction factor is also clearly evident. A higher Reynolds number appears a higher mass flow rate, a higher turbulent flow and a higher penetration of air in the hydraulic boundary layer (i.e., less thickness of the boundary layer). The friction factor increases by about (25 %), (37.5 %), and (41 %) for the cases of (I, II, III) for inclination angle of (30, 40, and 50) degree, respectively as shown in Fig (4), (5), and (6).

3.3. Effect of the Attack Angle of Generators on the Duct Friction Factor:

The angle of attack of generator is one of the major influencing factors which affects on the pressure head loss. The friction factor is promoted by about (30%), (35%), and (39.5%) for the case of (III) at the inclination angle of (30, 40, and 50) degree respectively. Fig (7), (8) and (9) reveal the effect of varying of the angle of generators on the friction factor for cases (I, II, and III) respectively, keeping the size of generators constant. For each case, the (Re) number was kept constant and the angle of attack was varied for the three values. The results shows explicitly that the friction factor is affected greatly with the changing of the inclination angle because the cross-sectional area of the channel flow at the location of the stick of the generators decreases with the angle of attack. In other wards, the increase in the area of the vortex generator across the flow direction increases serves as an obstacle in the flow direction. This leads to an increase in pressure drop between the leading edge and the trail of the generator. Increasing the angle of attack effect in increasing the vortex circulation and a higher value of friction factor is attained. Of course, this is associated with a high rate of heat transfer. The friction factor correlation as effected by the angle of attack is:

$$f = \frac{C}{Re^d} \frac{b}{p/2} \quad (8)$$

The values of the variables (C, d) in Eq. (8) are tabulated in Table (1).

4. CONCLUSIONS

It is extracted that:

- 1.The existence of the vortex generators in the flow direction increases the turbulence of the flowing fluid in the channel, and this turbulence is directly proportional with the obstacle area across the cross-sectional area of the flow direction. A large vortex generator area gives a high turbulence flow, a great pressure head losses and a high power supply.
- 2.The vortex generator area across the flow direction increases as the friction factor increases. The vortex generator area increases with angle of attack and the number of generators.

ACKNOWLEDGMENT

The author gratefully acknowledges the head of the Mechanical Engineering Department in the University of Anbar who afforded the equipments to complete this research.

REFERENCES

- [1] Chegini, H. & Chaturvedi, S.K., "An Experimental and Analytical Investigation of Friction Factors for Fully Developed Flow in Internally Finned Triangular Ducts", Journal of Heat Transfer, Vol. 108, August 1986, pp. (507–512).
- [2] Rohsenow, W.R., Hartnett, J.P., and Garric, E.N., "Handbook of Heat Transfer Applications", Vol.1, Chapter 7, McGraw–Hill, Inc., New York, 1985.
- [3] Aly, A.M.M., Trupp, C. & Gerrard A.D., "Measurements and Prediction of Fully Developed Turbulent Flow in an Equilateral Triangular Duct" J. of fluid Mech. 1978, Vol.85, part 1, pp. (5– 83).
- [4] Altemani, C.A.C., & Sparrow, E.M., "Turbulent Heat Transfer in an Unsymmetrically Heated Triangular Duct", ASME Journal of Heat Transfer, Vol. 102, November 1980, pp. (590–597).

- [5] Tiggelbeck, St., Mitra, N.K., & Feibig, M., “Comparison of Wing Type Vortex Generators for Heat Transfer Enhancement in Channel Flows”, ASME Journal of Heat Transfer, Vol. 116, Nov. 1994, pp. (880–885).
- [6] Wroblewski, D. E., and Eibeck, P. A., “Measurements of Turbulent Heat Transport in a Boundary Layer with an Embedded Streamwise Vortex”, Int. J. Heat Mass Transfer, Vol. 34, No. 7, 1991, pp. (1617–1631).
- [7] Dep, P., Biswas, G., and Mitra, N. K., “Heat Transfer and Flow Structure in Laminar and Turbulent Flows in a Rectangular Channel with Longitudinal Vortices”, Int. J. Heat Mass Transfer, Vol. 38, No. 13, 1995, pp. (2427–2444).
- [8] Biswas, G., and Chattopadhyay, H., “Heat Transfer in a Channel with Built-in Wing-Type Vortex Generators”, Int. J. Heat Mass Transfer. Vol. 35, No. 4, 1992, pp. (803–814).
- [9] Biswas, G., Dep, P., and Biswas, S., “Generation of Longitudinal Streamwise Vortices—A Device for Improving Heat Exchanger Design”, ASME Journal of Heat Transfer, Vol. 116, August 1994, pp. (588–597).
- [10] Zhu, J. X., Fiebig, M., and Mitra, N. K., “Numerical Investigation of Turbulent Flows and Heat Transfer in a Rib – Roughened Channel with Longitudinal Vortex Generators”, Int. J. Heat Mass Transfer, Vol. 38, No. 3, 1995, pp. (495–501).
- [11] Kotcioglu, I., Ayhan, T., Olgun, H., and Ayhan, B., “Heat Transfer and Flow Structure in a Rectangular Channel with Wing-Type Vortex Generator”, Tr. J. of Engineering and Environmental Science, 22, 1998, pp. (185–195).
- [12] Zangana, H. E., “Effect of Delta-Winglet Vortex Generators on a Forced Convection Heat Transfer in an Asymmetrically Heated Triangular Duct”, Master Thesis, University of Anbar, Engineering College, Sep. 2005.
- [13] Spencer, E.A., “Progress on International Standardization of Orifice Plates for Flow Measurement”, Int. J. Heat & Fluid Flow, Vol. 3, No.2, June 1982, pp. (59–66).
- [14] Streeter Victor L. & Wylie E. Benjamin, “Fluid Mechanics “, 7th Edition, McGRAW-HILL, Inc., 1979.

NOTATIONS

- A: Cross-sectional area of the channel.
 D_h : Hydraulic diameter.
 L: Axial length of the test section.
 f : Dimensionless Friction factor.
 ΔP : Pressure gradient between the taps.
 \bar{u} : Average velocity of the air.
 \dot{m} : Air mass flow rate.
 β : Angle of attack of generator.
 ρ : Density of air.
 μ : Absolute Viscosity of air.
 ν : Kinematic Viscosity of air.

Table (1): values of variables (C, d) in Eq.(8)

	I			II			III		
β	30°	40°	50°	30°	40°	50°	30°	40°	50°
C	904.65	612.06	219.14	353.49	88.50	87.83	176.16	108.96	250.97
d	1.296	1.284	1.204	1.198	1.089	1.1006	1.129	1.1038	1.196

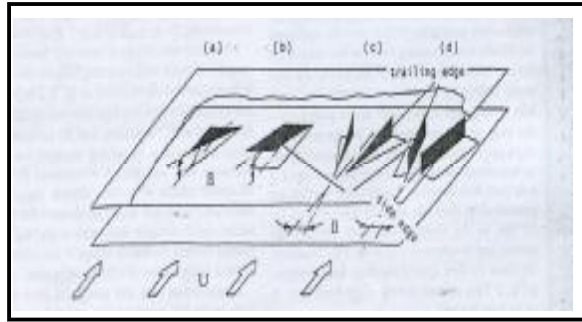

Figure (1): longitudinal vortex generators types; a-delta wing, b-rectangular wing, c-delta winglet pair, d-rectangular winglet pair [10].

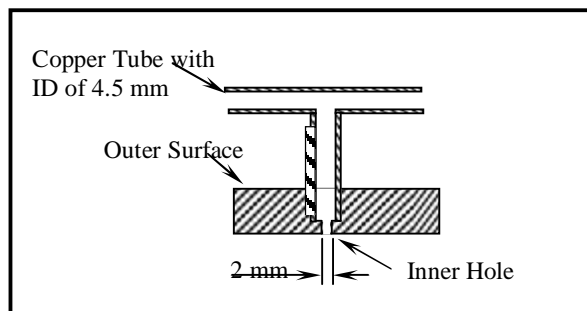

Figure (2): static pressure hole [3].

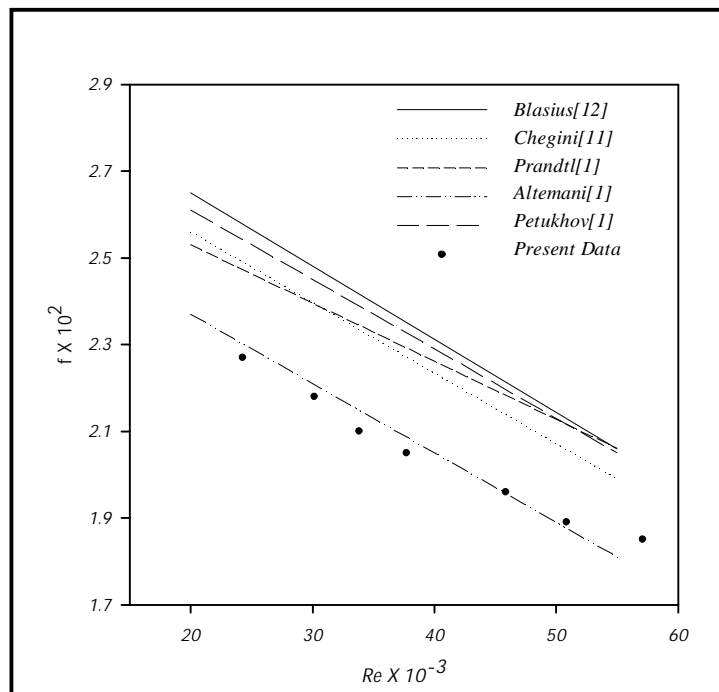

Figure (3): friction factor for the base case.

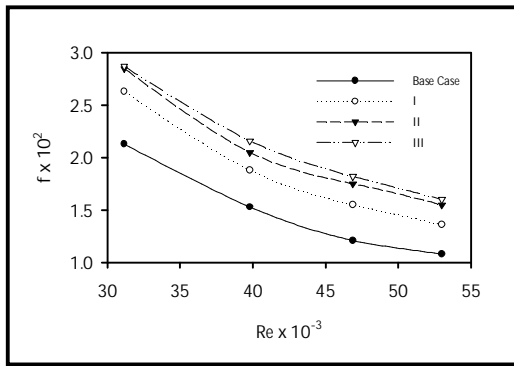

Figure (4): friction factor at angle of 30 deg.

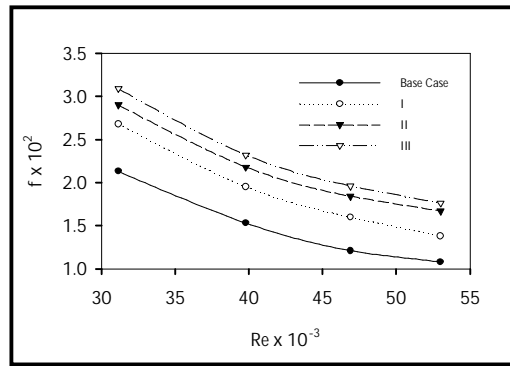

Figure (5): friction factor at angle of 40 deg.

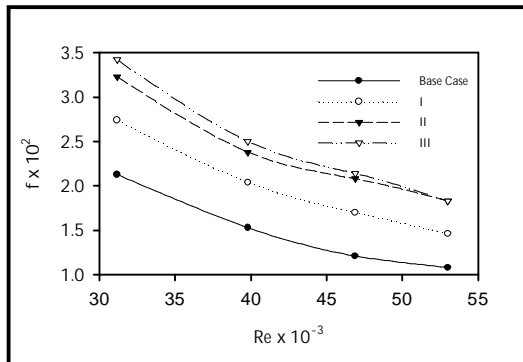

Figure (6): friction factor at angle of 50 deg.

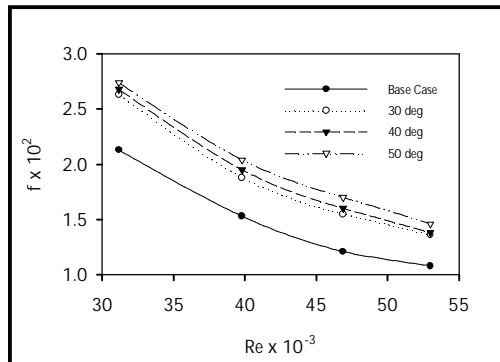

Figure (7): friction factor for single pair of vortex generators.

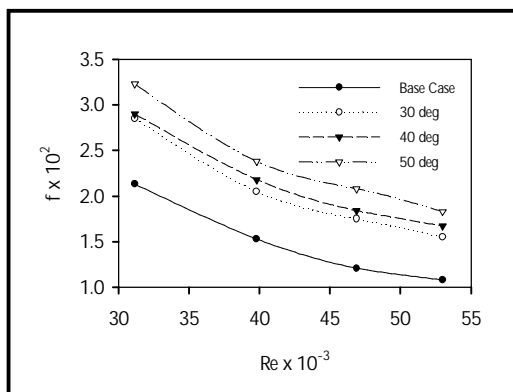

Figure (8): friction factor for double pairs of vortex generators.

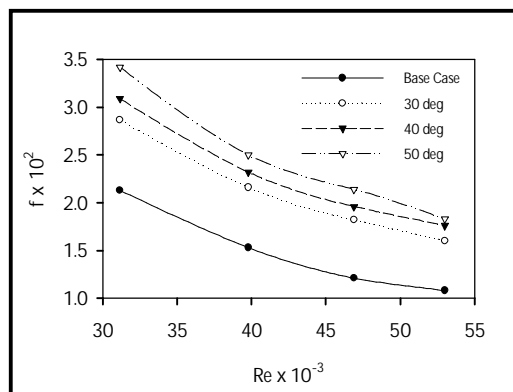

Figure (9): friction factor for triple pairs of vortex generators.

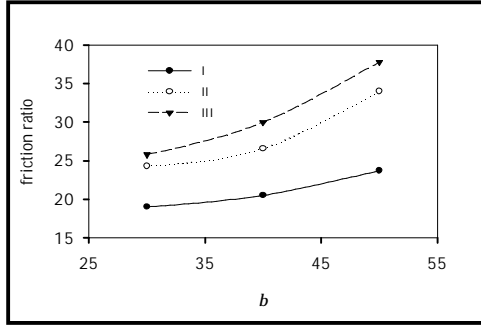

Figure (10): friction factor ratio for the three cases at Re=31,000.

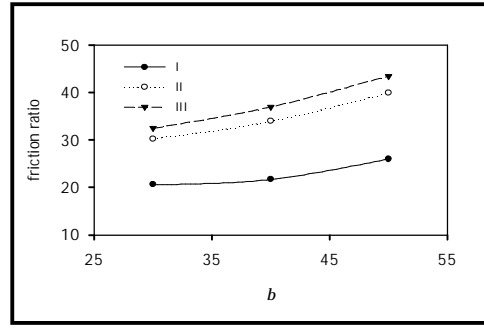

Figure (11): friction factor ratio for the three cases at Re=53,000.

تأثير مولدات الدوامية على معامل الاحتكاك في مجرى مثلث متساوي الأضلاع

حمدي عماد الدين احمد
كلية الهندسة - جامعة الانبار - قسم الهندسة الميكانيكية

الخلاصة

إن الهدف الأساس من هذا البحث هو دراسة تأثير مولدات الدوامية على معامل الاحتكاك لجريان تام النمو. يمكن توليد الدوامات الطولية داخل مجرى الجريان من خلال غرز أو احتواء نتوءات أمثال مولدات الدواية (VGs) في جدار المجرى والتي تصنف إلى الجناح المثلث، والجناح المستطيل، وزوج الجنيح المثلث، وزوج الجنيح المستطيل. حيث تمزق الدوامات الطولية نمو الطبقة المتاخمة وتؤدي إلى تحسين معدل انتقال الحرارة بين المائع الجاري وسطح المجرى الناقل للحرارة، بيد أن هذا التحسن في انتقال الحرارة يصاحبه زيادة في هبوط الضغط على طول القناة. لذا تم دراسة معامل الاحتكاك تجريبياً لجريان الهواء تام النمو في مجرى مقطعه العرضي مثلث متساوي الأضلاع باستخدام أزواج من مولدات الدوامية نوع الجنيح المثلث إذ تراوح رقم رينولدز من (31,000) إلى (53,000). حيث تم دراسة ثلاث حالات والتي هي: زوج مفرد، وزوجان، وثلاث أزواج من مولدات الدوامية مغمورة في الطبقة المتاخمة المضطربة ولثلاث زوايا ميلان لمولدات الدوامية والتي هي (30, 40, 50) درجة في حين بقي حجم مولدات الدوامية ثابتاً. أظهرت النتائج بان معامل الاحتكاك قد ازداد بنسبة (43.5 %) عند تغيير زاوية ميلان مولد الدوامية من (30) درجة إلى (50) درجة لحالة ثلاث أزواج من مولدات الدوامية مقارنة مع الحالة القياسية (بدون استخدام مولدات دوامية).